

6

5

4

3

2

1

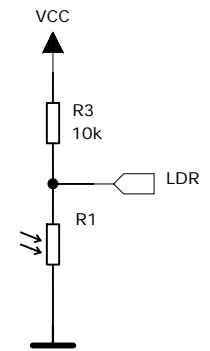
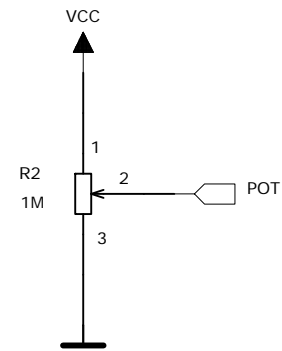
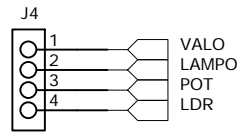
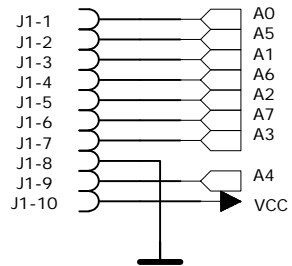

Jännitettiin J2 on optio.  
Liitintä tarvitaan vain jos  
liittimen J1 kautta ei tule  
käyttöjännitettä VCC.

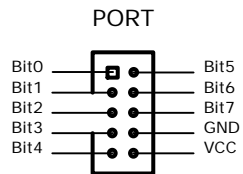
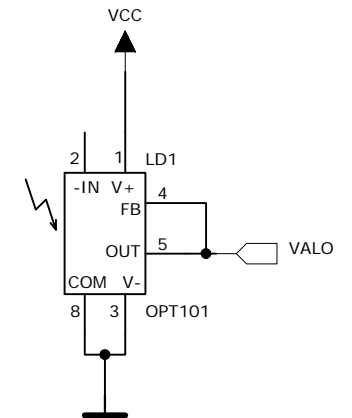
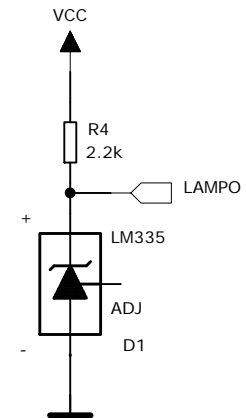
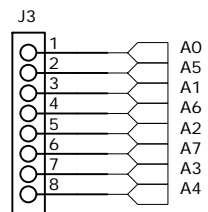
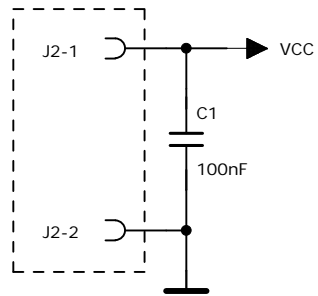

TietoPetri Oy

<http://www.tietopetri.fi>

DRAWN:

DATED:

TITLE:

PKo

01.04.2010

ADC-LEVY

CHECKED:

DATED: