

6

5

4

3

2

1

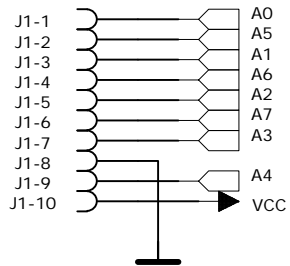

Jännitettiin J2 on optio.
Liittintä tarvitaan vain jos
liittimen J1 kautta ei tule
käyttöjännitettä VCC.

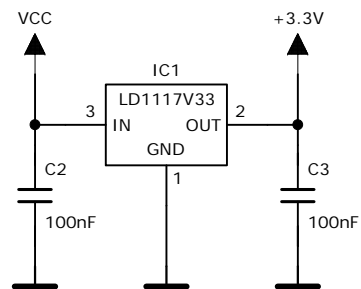
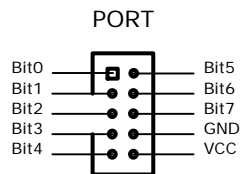
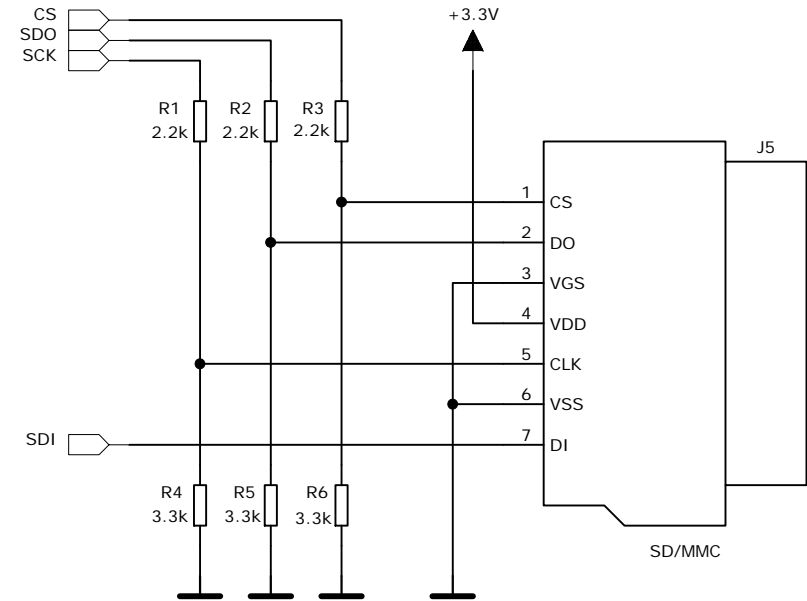
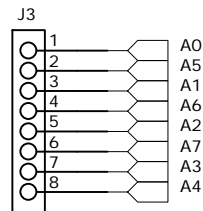
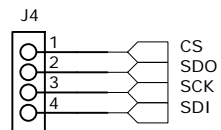
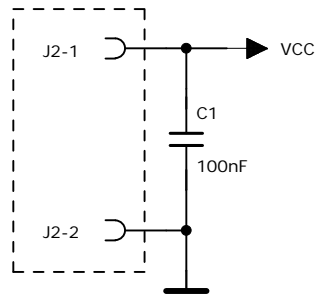

TietoPetri Oy

<http://www.tietopetri.fi>

DRAWN:

PKo

DATED:

01.06.2010

TITLE:

SD/MMC-LEVY

CHECKED:

DATED: